

Technical specification

Genier ACE 40 FS

Mixer kettle

Net volumes:

- Net / Gross: 40 / 52 liters

Heating:

- Electric
- Steam

Installation:

- Freestanding

Mixer:

- Mixing speed 10 - 160
- 7 mixing modes, inc. auto-reverse
- Lid-open-mix when lid opened or kettle tilted
- Three-piece mixer tool with removable scrapers

Construction:

- Electronic tilting with adjustable tilt-back function
- 600mm tilting height
- Jacket max. pressure 1.5 bar [128 °C]
- Kettle interior AISI 316 stainless steel, outer body AISI304L
- Removable stainless steel lid that can be rotated 360 degrees in place
- Spring-loaded lid hinge
- Lid has a large grid opening with a separate lid for the grid

Control system

- 10-inch touchscreen with icon-based UI
- Temperature range 0...125 °C
- Automatic control based on jacket temperature, food temperature or temperature difference
- Cooking water added and calculated automatically
- Cooking programs are stored in memory
- Guidance and alerts during cooking
- Start time of the cooking programme can be set
- HACCP monitoring during cooking and storage of reports in memory
- User profiles enable password-protected cooking functions
- Automatic maintenance calculators and assistants
- Maintenance diagnostics mode for troubleshooting errors



Optional functions

- Real-time HACCP report during cooking
- Scalable cooking programs with batch number
- Scale function
- Foot pedal that enables e.g. lid-open-mixing
- Washing hose and storage compartment
- Wireless link
- Pt100 connection to external HACCP system
- Energy optimisation connection
- Hot cooking water connection and switch
- Soft water connection
- Cooling with mains water
- Cooling with ice water circulation
- Emptying valve
- Floor-mounted installation

Accessories

- Measurement stick
- Strainer plate
- Washing tools
- Whipping tool
- Mixing hook
- Folding tool
- Wall holder for kettle tools
- Trolley for kettle accessories
- GN-tray holder
- Trolley for GN-tray

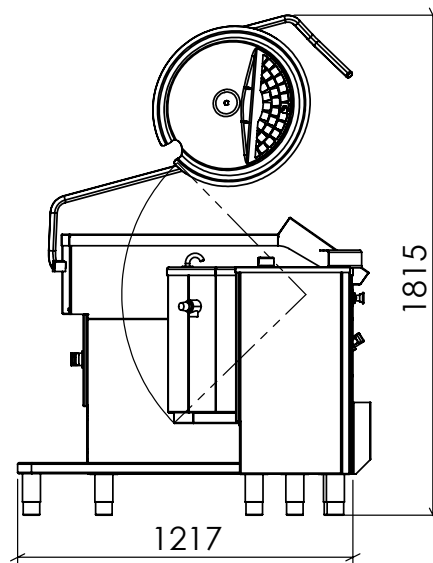
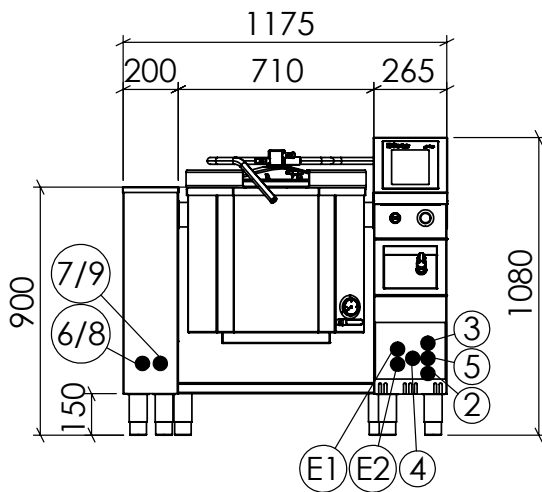
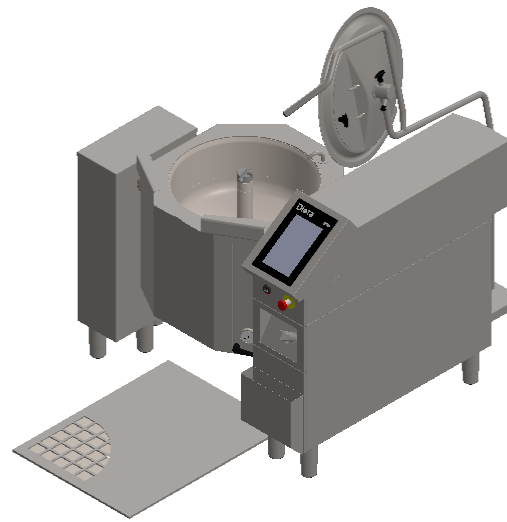
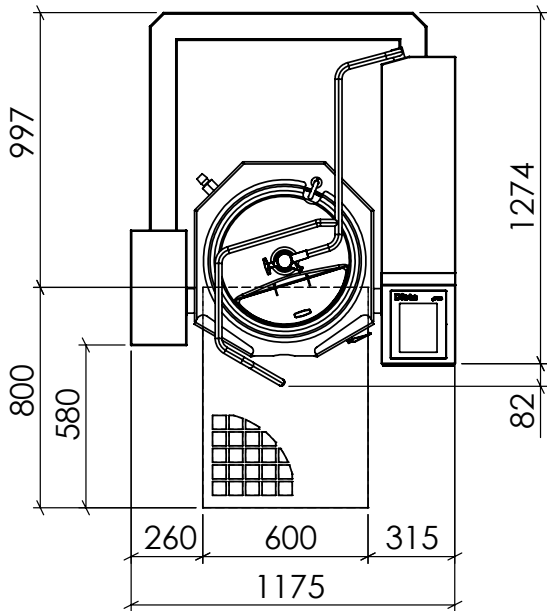

Technical information - Genier ACE 40 FS

- Volume, net/gross: 40 / 52 liters
- Weight, net/with transport package: 230 / 310 kg
- Tilting height: 600 mm
- Connections (flexible):
- Electric (Electric model) #E1 14,5 kW, 400V 3~, 32A, 50/60 Hz
- Electric (Steam model) #E2 1 kW, 230V 1~, 16A, 50/60 Hz
- Electric (Option) #E3 Information refrigeration unit
- Cold water #2 DN 15, G1/2", 200...600 kPa [2...6 bar], Filtered to 15 µm *
- Warm water (Option) #3 DN 15, G1/2", max 60 °C, 200...600 kPa [2...6 bar]
- Hot water (Option) #4 DN 15, G1/2", max 80 °C, 200...600 kPa [2...6 bar], Filtered to 15 µm *
- Softened water (Option) #5 DN 15, G1/2", 100...600 kPa [1...6 bar], Filtered to 15 µm *
- House steam (Steam model) #6 DN 15, G1/2", 150...200 kPa [1,5...2 bar], 25 kg/h
- Condensate (Steam model) #7 DN 15, G1/2", Counter pressure 0 kPa [0 bar], downward line

* Water for kettle jacket:

Filtered to 15 µm, 0...40 °C, max 5 °dH, conductivity 30... 1000 µS/cm, chloride max 100 mg/l, chlorine max 0,25 mg/l, pH 6,5...9,5

Genier ACE - Technical descriptions

INSTALLATION

- Free Standing Installation .
- Without the need for floor bolting. Making the kettle easy and inexpensive to install, and easy to move as needed.
- No need to pierce the waterproofing of the floor.

HEATING

- Electric model.
- Steam model.

CONTROLLER

- Large and easy-to-read 10-inch touch screen with clear and far-sighted information
- Electronic control for heating, water filling, and mixing.
- Large and easy-to-use control buttons for adjusting kettle functionalities. Only available functions are active.
- Guidance information messages, instructions for energy-efficient use, and error messages.
- Ability to set far-visible visual signals to guide user action.
- The touch screen can be locked during washing to avoid incorrect presses.
- An unactive touch screen can be placed in an energy-saving sleep mode, from where it returns to immediate use.

HEATING

- The heating can be by automatic temperature control based on the food temperature, by the temperature of the jacket, or by the difference between these temperatures.
- In food temperature control, intelligent heating control to prevent burnout and reduce energy consumption.
- Temperature display with 1 °C resolution with a clear numerical display. Adjustment range 0... 125 °C.
- The maximum pressure of the jacket is 1.5 bar.

MIXER

- Two-way rotary bottom mixer integrated into the bottom of the kettle, free to use in all positions.
- The mixing tool can be disassembled into three (3) separate parts weighing up to 2.5 kg. Enabling ergonomic handling of the tool when placing in and removing from the kettle.
- Mixing tool that can be disassembled and washed completely in a 500x500mm washing basket at a washing machine.
- The mixing tool is well suited for e.g. cold preparation, crushing, pureeing (eg mashed potatoes), mixing of mixes, kneading and whipping.
- Parts of the mixing tool can be replaced with special tools according to the prepared product's requirement.
- Stepless mixing speed selection between 10-160 (10-160 rpm)
- Seven (7) ready-made mixing programs are suitable for versatile food production. Mixing programs as needed can be self-modified.
- The mixer stops automatically if the kettle lid is opened.
- The mixer can be activated with a pulse switch when the lid is open, the kettle is tilted or the kettle is tilting,

FOOD WATER FILLING

- Automatic water filling is based on the selected liters of water or the amount of water added is measured.
- The water spout is located on the edge of the pot. It can be used with the lid closed and the kettle tilted.

TILTING

- Electric tilt.
- An adjustable tilt-back function that automatically stops the product from emptying from the kettle when tilting stops.
- When emptying, the kettle tilts from the height of 600 mm, which allows ergonomic working height and emptying even in large containers.

LID

- The lid is a durable stainless steel lid that is equipped with a spring-loaded hinge.
- The lid has a large safety grid (incl. separate lid) for adding ingredients.
- The lid is removable for transfer to the wash.
- The kettle lid can be rotated 360 degrees in place, allowing the lid to be wiped without reaching over the kettle.

CONSTRUCTION

- The top rim of the kettle is separated from the heating area so that the top of the rim does not become hot during cooking.
- Volume markings on the inner surface of the kettle.
- Kettle inner parts in contact with food made of AISI 316 acid-proof stainless steel.
- Kettle covers, stand, and other parts are AISI 304 stainless steel.

PROGRAMS

- User-programmable multi-stage cooking processes are organized into folders by product type.
- In cooking programs, the user can specify steps to control the heating/chilling temperature and time, the mixing, and the amount of water to be added.
- Instructions and alarms that guide the user can be set in the cooking program, e.g., the addition of raw materials and inspection of the product.
- The most used cooking programs can be moved to the Favorites for fast access.
- A side panel can be swiped visible, showing the progress of the multi-stage cooking program and the future steps and editing the future steps during the program.
- The user can schedule their cooking programs to start automatically
- The user can set the egg timer with its own alarm

HACCP & REPORTS

- The HACCP reports from the cooking programs stored in the kettle memory can be viewed on display.
- Electricity and water consumption reports can be viewed from the cooking programs as well as from the kettle memory.
- The kettle stores usage reports, monitors the need for key maintenance tasks and the schedule of components. Informs and instructs the user on maintenance procedures and service contact.
- Reports in the kettle's memory can be transferred with a USB stick.

WASHING PROGRAMS

- Ready-made washing programs
- The washing attachments tools, which can be replaced, enables automatic cleaning of the inner surfaces of the kettle.
- Washing programs heat and dispense the wash water and start the washing tool.
- Wash complete notification with a summary of the energy and water consumption of the washing program.

USERS AND SETTINGS

- Password-protected access levels allows setting by user what cooking programs and/or functions they are allowed to perform.
- Service mode with service diagnostics and actuator tests directly from the controller display
- The user can customize the basic settings to suit his own needs.

SAFETY FUNCTIONS

- The pressure switch stops heating if the pressure in the steam jacket rises too high.
- The safety valve opens if the pressure in the kettle rises above the permissible level.
- The float switch prevents heating if there is too little water in the steam generator.
- A note text on display indicates the need for power separation.
- The tilt motor overcurrent limit prevents the motor from breaking.
- The tilt motor is equipped with a mechanical brake that prevents unintentional movement.
- The overcurrent and overheating limits of the mixing motor protect the motor.

COMPLIANCE

- The kettle fulfills DIN18855-1 standard for Rapid Kettle
- Compliant to CE requirements for safety
- Prevention of water pollution by backflow in accordance with EN 1717
- Manufactured in ISO 9001 certified factory.

FACTORY INSTALLED OPTIONS

- Extended cooking programs and HACCP reporting
 - Cooking programs automatically scale according to the desired batch size.
 - Cooking programs are suitable for transferring between different size kettles.
 - Alarm tone for program completion and/or guidance
 - HACCP reports from cooking programs can be set to include the recipe, batch identifiers, and total volume to identify them with kitchen's production control system.
 - HACCP reports stored from cooking programs can be monitored in real-time during cooking on the kettle display.
- Weighing, which weighs the ingredient to be added to or the product taken from the kettle.
- Foot pedal for hands-free control of safety mixing, tilting, and water addition.
- Wash hose with pistol and storage case
- Active central axis that provides additional heating or chilling surface.
- Extra Pt100 sensor for food temperature that can be connected to an external temperature monitoring system.
- Chilling performed with tap water (food water) which flows to drain [CH3]
 - Chill media is tap water that is led continuously to drain
 - Activated from the control panel or as a part of a program
 - Chilling temperature can be set. The Chill-Hold function is activated if a chill temperature is set
 - At the end of the chilling process, the jacket is emptied automatically [to drain]
- Microfilter to be installed in the inlet water connection, replaceable filter cartridges.
- Emptying pipe, 2", for the front of the kettle. Echtermann valve by default
- Emptying pipe, 2.5", for the front of the kettle.
- Emptying pipe, 2.5", at kettle bottom with clamp connection to the user's own valve
- Floor-mounted installation with the feet bolted to the floor
- Subsurface installation frame for floor-mounted installation

ACCESSORIES

- Measurement stick
- Strainer plate
- Washing tools
- Whipping tool
- Mixing hook
- Folding tool
- Wall holder for kettle tools
- Trolley for kettle accessories
- GN-tray holder
- Trolley for GN-tray

