

EVOMULTI

EVOLUTION AT YOUR SERVICE



rational
PRODUCTION



reddot award 2017
winner



Rational
PRODUCTION

EVOMULTI

EVOLUTION AT YOUR SERVICE

A Rational Production innovation, the ALUFRAME® concept of construction, means the EVOMULTI is the lightest, most compact, convection heated multi-portion trolley on the market, without compromise to performance, ergonomics or operation.



reddot award 2017
winner

The reduced, linear appearance of the EVOMULTI is based on a complex design which assures that the service trolley satisfies high demands of ergonomics and functionality.

EVOMULTI



EVOMULTI is the trolley for the transportation and serving of food at the point of consumption. Ideal for reheating and/or maintaining the temperature of meals pending distribution, it is designed to function in Cook&Serve, Cook&Chill and Cook&Freeze,

and even cook some simple food. It can be configured in different sizes with heated, refrigerated, plate warmer and neutral compartments, and is enhanced by a wide range of optional to meet even the most demanding requirements.

Functions

MAINTAINING

It keeps hot and cold food at the correct temperatures, in accordance with HACCP requirements.



REGENERATION

It keeps the cold chain of all foods which can be regenerated as and when needed, in accordance with HACCP requirements.

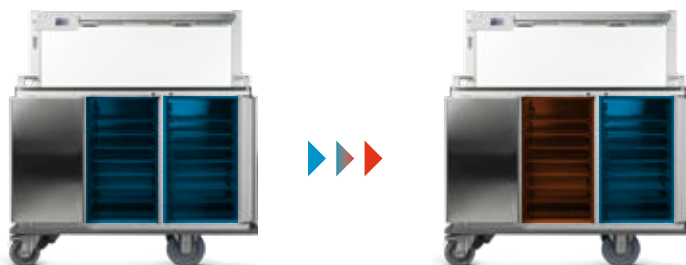

SIMPLE COOKING

It can be used for simple cooking, at temperatures of up to 170°C.



CONTAINERS

For multi-portion use

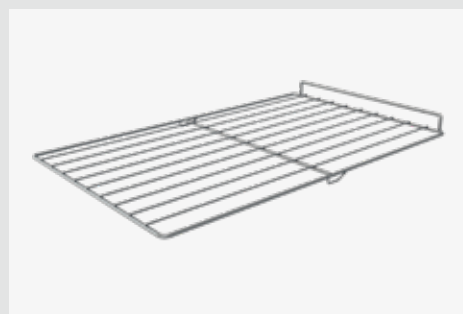

GRILLES

To distribute disposable containers or plates



Performance

THERMAL RETENTION

The superior thermal insulation and the smart design of the internal compartments provide consistent thermal retention over time, for maximum safety in all situations.

HEAT RETENTION

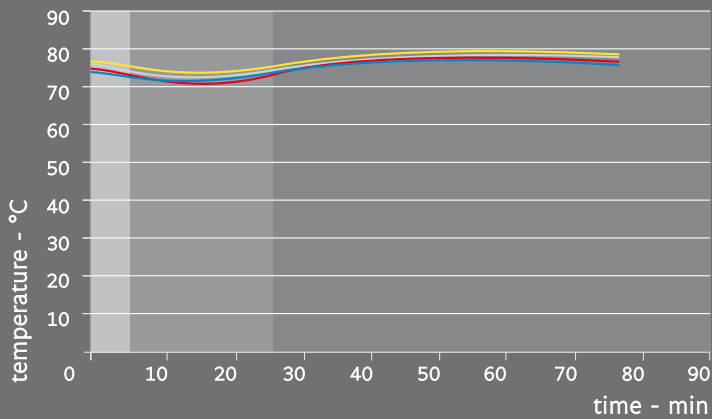

COLD RETENTION

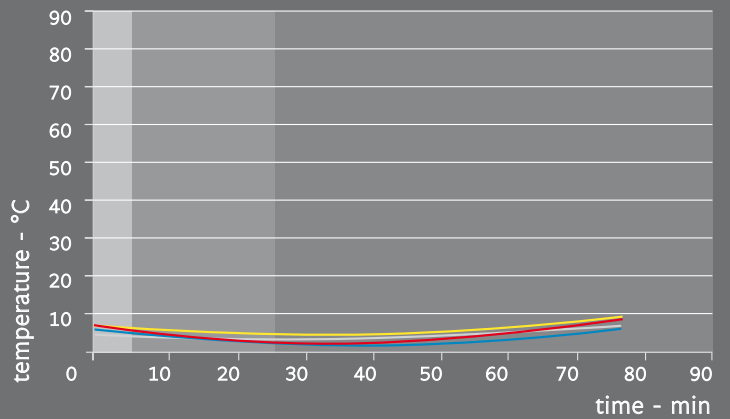

Key:

0-5 min | Filling

5-25 min | Temperature cycle

25-90 min | Retention

QUALITY RESULTS

Thanks to the extensive research on internal air flows, EVOMULTI provides gentle regeneration, without stressing the food, and allowing it to maintain its organoleptic qualities..

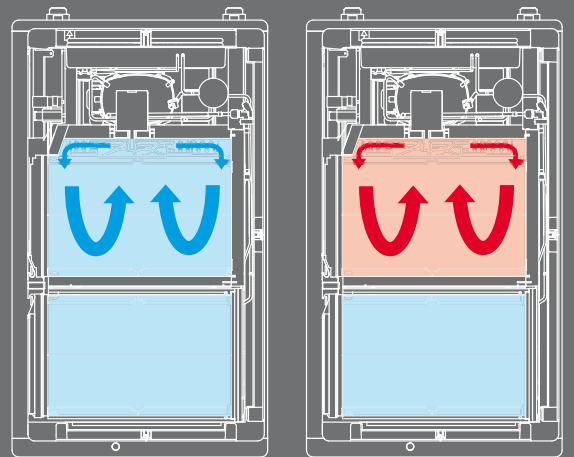

VERSATILITY OF USE

Various temperature options (from -3°C up to 170°C), with different electrical standards, including single-phase, allows EVOMULTI to be used in all operating contexts. A preset recipe list is also available to ease the work of the operator.



Distribution modes

EVOMULTI has two different distribution modes, mobile distribution (A) from room to room mainly used in hospitals, clinics and care homes for the elderly and stationary distribution (B) used in refectories in hospitals, clinics, care homes for the elderly, schools and workplaces and catering services.

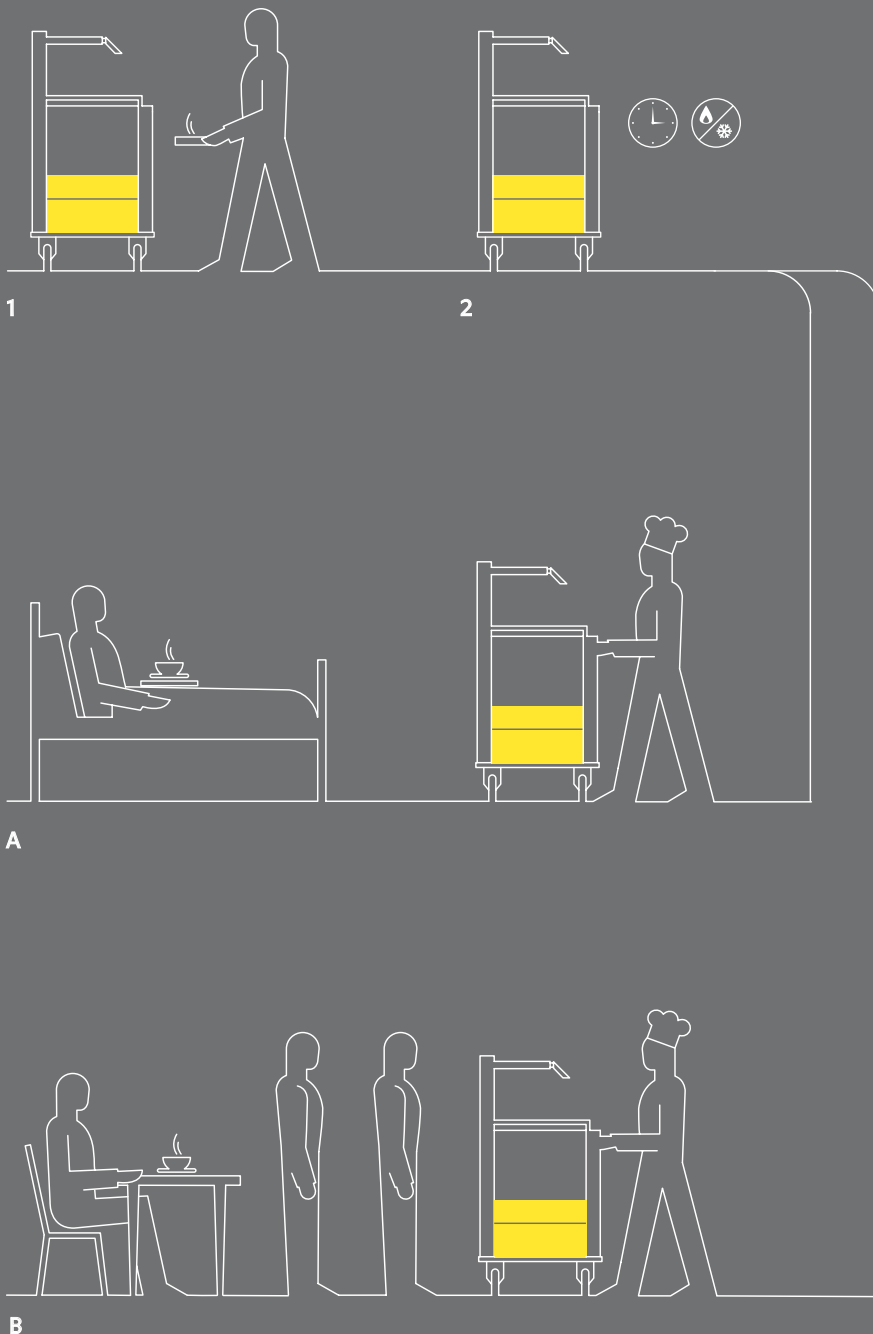

1. Charge

2. Switching on:

Regeneration
Cooking
Maintaining

A. Mobile distribution:

Hospitals
Clinics
Homes for the elderly

B. Stationary distribution:

Hospitals
Clinics
Homes for the elderly
School canteens
Workplace canteens
Catering service

EVOMULTI DESIGN



HYGIENE

Sleek design, rounded corners.



ECO-SUSTAINABILITY

100% recyclable frame.



ERGONOMICS

Designed with both the operator and user in mind.



FUNCTIONAL FEATURES

Accessories completely integrated within the base of the product



ALUFRAME The use of aluframe technology, changed by the aeronautic world, has allowed the cage frame to be developed with screw joints, without welding and characterised by high sturdiness

and light weight. ALUFRAME® permits easy component replacement. Furthermore, the athermal profile inserts around the entire perimeter improves trolley insulation.



reddot award 2017
winner



SIMPLE MAINTENANCE

Possibility of replacing any part of the frame and trolley.



STURDY AND LIGHTWEIGHT

ALUFRAME® lightweight aluminium frame.



PROTECTION

Frame buffers to ensure total protection for doors even when open.

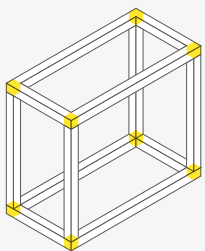

High structural resistance perimeter frame.

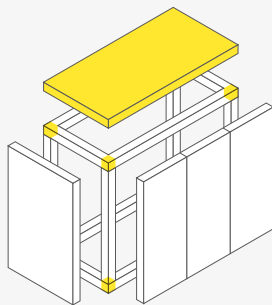

Simple and fast assembly.

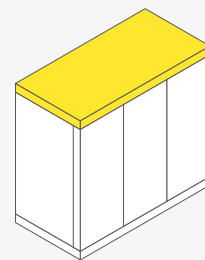

High sturdiness.

EVOMULTI SMALL

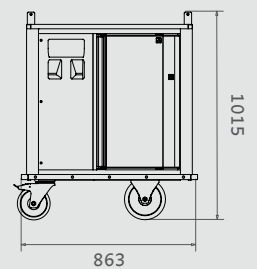
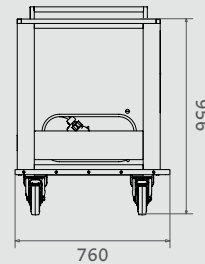
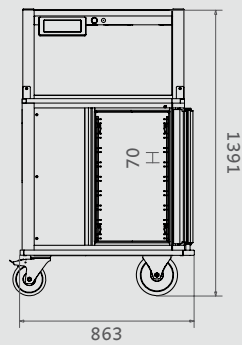
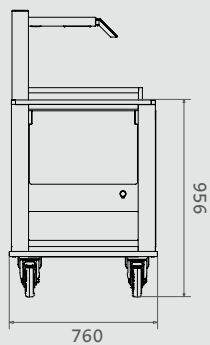

EVOMULTI LARGE

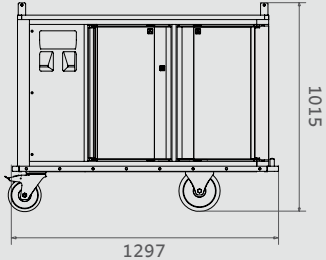
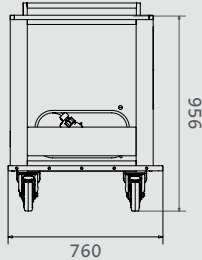
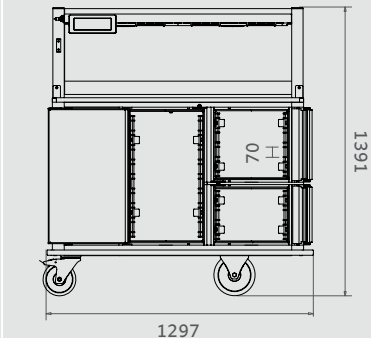
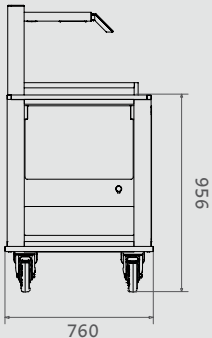

EVOMULTI CONFIGURATIONS



EVOMULTI OPEN
options



HOT PLATE



EVOMULTI BRIDGE
options



SNEEZE GUARD GLASS



HOT PLATE



HEATING LAMPS



AVAILABLE COMPARTMENTS



HOT
Ventilated heating compartment
(max. temp. 170°C)



COLD
Static cooling compartment
(min. temp. -3°C)



COMBINED
Combined heating/cooling convection compartment
(min. -3°C; max +170°C)



PLATE WARMER
Static heating compartment
(max. temp. +130°C)



NEUTRAL
Insulated neutral compartment

Sections

EVOMULTI SMALL

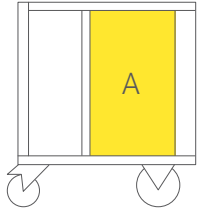

- 1 COMPARTMENT
- A N° 8 containers GN 1/1

EVOMULTI LARGE

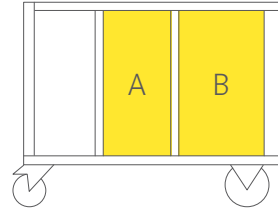

- 2 COMPARTMENTS
- A N° 8 containers GN 1/1
- B N° 8 containers GN 1/1

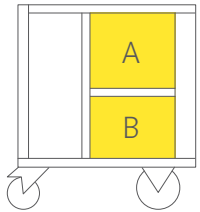

- 2 COMPARTMENTS
- A N° 4 containers GN 1/1
- B N° 3 containers GN 1/1

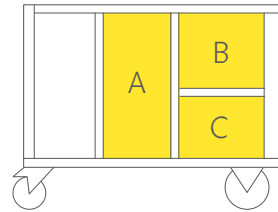

- 3 COMPARTMENTS
- A N° 8 containers GN 1/1
- B N° 4 containers GN 1/1
- C N° 3 containers GN 1/1

Use

The single section compartment also comes without fixed supports, with an extractable rack (optional) and a EVOSERV JOLLY service trolley.



Fixed supports



Extractable rack

EVOMULTI CONTROL PANEL

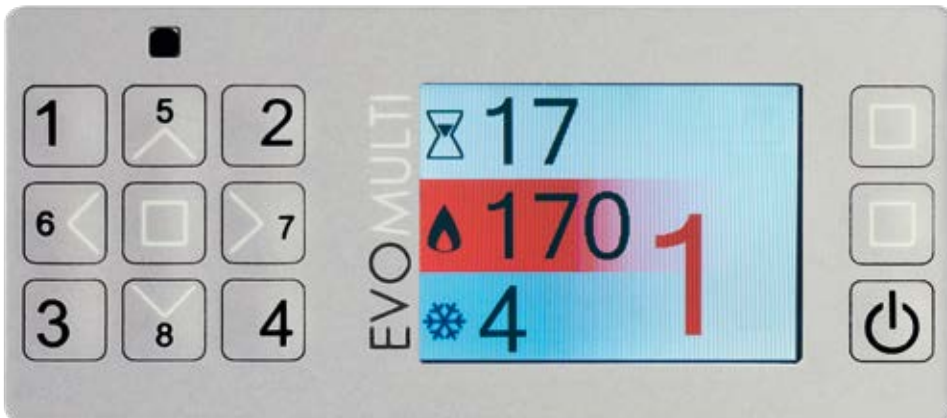

DISPLAY Indicates the temperature cycle in progress, the temperatures of the internal compartments with relative real time temperature graph, countdown to the end of the cycle and alarms.

PUSH-BUTTON PANEL Provides complete control and management of the trolley. 8 cycles can be preset with a maximum of 5 steps each. There is also a “Recipe” section (central button) with a maximum of 100 programmable items. When the trolley is in standby, the operator can access the menu and programme the trolley as required using the browsing keys (arrows). ON/OFF key.

STATUS LED This uses a number of different mode colours:

- **BLUE** trolley is in cooling mode;
- **YELLOW** temperature cycle in progress;
- **FLASHING YELLOW** temperature cycle completed (pending confirmation by the operator);
- **RED** alarm signal (pending control by the operator).



USB PORT To update firmware, upload and download traceability data and trolley programming data. There is also a function that allows simple duplication of settings from one EVOMULTI to another.

TEMPERATURE CORE PROBE To record the temperatures of foods pre and post temperature cycle (optional available with Comm. USB and Comm. PLUS configurations).

EVOMULTI TRACEABILITY

HACCP

registration and verification

A data registration and verification system that allows continuous monitoring over time complies with strictest HACCP requirements. This is fully available on EVOMULTI, and all the Rational Production products at various levels.



COMMUNICATOR USB



This option requires a modification to the standard trolley and the use of the Communicator USB software

- Download of data on the temperature cycles completed via the standard USB port, display of temperature graphs and saving of data on dedicated software.
- Setting of general machine and temperature cycle parameters using the Communicator USB software, to be uploaded via the standard USB port.

COMMUNICATOR PLUS



This option requires a modification to the standard trolley and the use of the Communicator PLUS software

- Download of data on the temperature cycles completed via the RJ45 cable or Wi-Fi, display of temperature graphs and saving of data on dedicated software.
- Download and real time data monitoring of the operation in progress.
- Setting of general machine and temperature cycle parameters using the Communicator PLUS software, via the RJ45 cable or Wi-Fi.

EVOMULTI OPTIONAL



FOLDAWAY SHELVES

The trolley can accommodate up to 3 foldaway shelves to provide maximum work space possible.



RACK PROVISION

Handling and distribution of meals is made easier thanks to the extractable rack that can be loaded onto the EVOSERV JOLLY service trolley, now even lighter and more compact.



PERIMETER BARRIER

In addition to the two side barriers assembled on the work surface, EVOMULTI comes with one or two additional barriers so as to close off all sides of the surface.



WHEEL OPTIONS

EVOMULTI also comes with a complete range of wheels: in galvanised or stainless steel, 160mm or 200mm in diameter. The standard setup foresees 4 galvanized steel wheels, two fixed 200 mm wheels and two swivel 160 mm wheels. A centralised brake and rotation release for the fixed wheels to allow the trolley to move sideways are also available.



TOWING HOOK

This is used to move up to 4 trolleys at a time, connected to each other using the towing devices.



LOCK

The trolley doors can be locked to prevent unauthorised people from opening them.



COLOURS

EVOMULTI is available in Yellow and Blue.

EVOMULTI ACCESSORIES



BAG HOLDER

Each foldaway shelf can be fitted with additional container supports/bag holders, with up to a maximum of 4 per trolley.



EVOSERV JOLLY

Lightweight and compact service trolley which can transport a rack, packed with food, by an EVOMULTI trolley with a rack fitting.



TRAYS AND LIDS

A complete range of different sized gastronorm trays and relative lids can also be supplied with EVOMULTI.

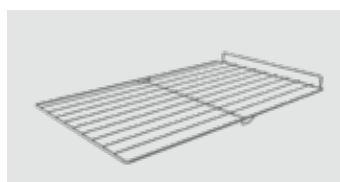

GRILLES

SHAPE	DIMENSIONS
GN 1/1	530x325 mm

To support disposable containers or plates inside the EVOMULTI compartments.

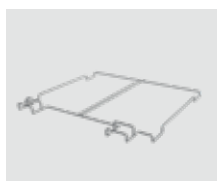
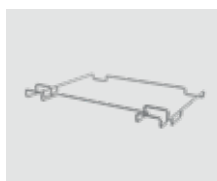

TRAY FITTINGS AND DISPLAY FIXTURES

Tray fittings and display fixtures are also available for EVOMULTI SMALL and LARGE to block the containers on the work surface or the light bridge.



COMMUNICATOR USB/PLUS SOFTWARE

Integrative software to use the EVOMULTI traceability functions. Available for deferred use (USB) or in real time (PLUS).



EXTERNAL TEMPERATURE CORE PROBE

To be used together with the optional Communicator USB and PLUS. It measures the temperature in the centre of the food and saves the data to the trolley memory bank.



DEPARTMENT ID

A useful accessory to assign the destination and/or attach documents to the trolley.

CONFIGURATIONS

	CODE	CONFIGURATION	COMPARTMENT FUNCTIONS AND CAPACITIES*			MAIN ELECTRICAL / VOLTAGE STANDARDS		
						400V 16A 3F+N+T	230V 16A 1F+N+T	230V 13A 1F+N+T
EVOMULTI S	1		8			7000 W - 5800 W	3600 W	3000 W
	2		8			7000 W - 5800 W	3600 W	3000 W
	4		4	3		3800W	3400 W	2600 W
	5		4	3		3800 W	3400 W	2600 W
	6		4	3		4250 W	3000 W	3000 W
	7		4	3		3800 W	3400 W	2600 W
	8		4	3		3800 W	3400 W	2600 W
	9		4	3		4250 W	3000 W	3000 W
	EVOMULTI L	C		8	8		7000 W - 5800 W	3600 W
D			8	8		7000 W - 5800 W	3600 W	3000 W
E			8	8		7400 W - 6200 W	3600 W	3000 W
F			8	4	3	7400 W - 6200 W	3600 W	3000 W
G			8	4	3	7400 W - 6200 W	3600 W	3000 W
H			8	8		7000 W - 5800 W	3600 W	3000 W
I			8	8		7000 W - 5800 W	3600 W	3000 W
J			8	8		7400 W - 6200 W	3000 W	3000 W
K			8	4	3	7400 W - 6200 W	3000 W	3000 W
L			8	4	3	7400 W - 6200 W	3000 W	3000 W

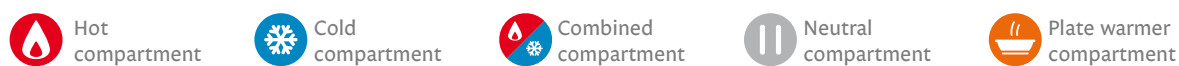

* The capacity of compartments is expressed in number of containers GN 1/1

TECHNICAL SPECIFICATIONS

EVOMULTI

DESCRIPTION	UNIT OF MEASURE	VALUE	
Dimensions (Open)	mm	SMALL 863x760x956	LARGE 1297x760x956
Dimensions (Bridge)	mm	SMALL 863x760x1391	LARGE 1297x760x1391
Wheel diameter	mm	FIXED 160 / 200 - SWIVEL 160 / 200	
Protection grade (Open)		IPX5	
Protection grade (Bridge)		IPX4	
Cold compartment minimum temperature	°C	-3	
Hot compartment maximum temperature	°C	170	
Plate warmer temperature	°C	130	
Work environment temperature	°C	from 5 to 38°C	
Coolant gas		R134a	

ELECTRICAL STANDARDS

400V 16A 3F+N+T	230V 13A 1F+N+T	230V 16A 1F+N+T	230V 20A 1F+N+T	230V 32A 1F+N+T	230V 16A 3F+T	230V 32A 3F+T
-----------------	-----------------	-----------------	-----------------	-----------------	---------------	---------------

PRODUCT DESCRIPTION

Application	Trolley for hot and cold meal distribution in multi-portion service.
Exterior	<p>Control panel: for the programming and use of the equipment, made from aluminium treated with a thick anodic oxidation coating.</p> <p>Push handles: ergonomic and in an impact-proof position.</p> <p>Bodywork: in aluminium treated with a thick anodic oxidation coating and ABS or HPL panels which are shock-resistant and easy to clean.</p> <p>Perimetral bumpers made of high-density polyethylene.</p> <p>Work table: in AISI304 stainless steel, available in a heated version upon request.</p> <p>Light bridge: optional accessory configurable with sneeze guard glass and heating lamps.</p>
Interior	<p>Chambers: in stainless steel with wide folding range and flush fitted joints for easy cleaning.</p> <p>Fan cover and tray support guard: in stainless steel, easy to remove and wash.</p> <p>Container racks: made completely from stainless steel, easy to remove and wash.</p>
Doors	<p>Consisting of an aluminium frame, and external HPL panel, a central panel in insulating material and an internal stainless steel panel.</p> <p>Opening angle: 270° or 180° depending on the trolley configuration.</p> <p>Automatic closure with built-in mechanism to avoid shocks and breakdowns.</p> <p>Optional lock and key closure.</p> <p>Completely impact-proof even when open.</p>
Materials	AISI304 steel, aluminium, synthetic material

EVOSERV JOLLY

DESCRIPTION	UNIT OF MEASURE	VALUE	
Dimensions	mm	SMALL 518x651x1016	LARGE 931x651x1016
Wheel diameter	mm	FIXED 125 / SWIVEL 125	
Cleaning		The trolley is washable in a washing tunnel at max 65°C water temperature.	
Rack type		GN	

PRODUCT DESCRIPTION

Application	Open neutral service trolley for rack transport.
Exterior	<p>Stainless steel base protected by plastic shock-proof buffers.</p> <p>Plastic rack guides.</p> <p>Ergonomic push handles made from aluminium protected by a thick oxidation coating.</p>
Materials	AISI304 steel, aluminium, synthetic material.

rational PRODUCTION

RATIONAL PRODUCTION srl

Via L. Galvani, 7/H
24061 Albano S. Alessandro (BG) Italy
T. +39 035.452.1203
F. +39 035.452.1983
info@rationalproduction.com
www.rationalproduction.com